

Article number: 204250M12125A1SK

Description: E+G levelling foot
GN 42-50-M12-125-A1-SK

Note: SK With nut, External hexagon at the bottom

Measures

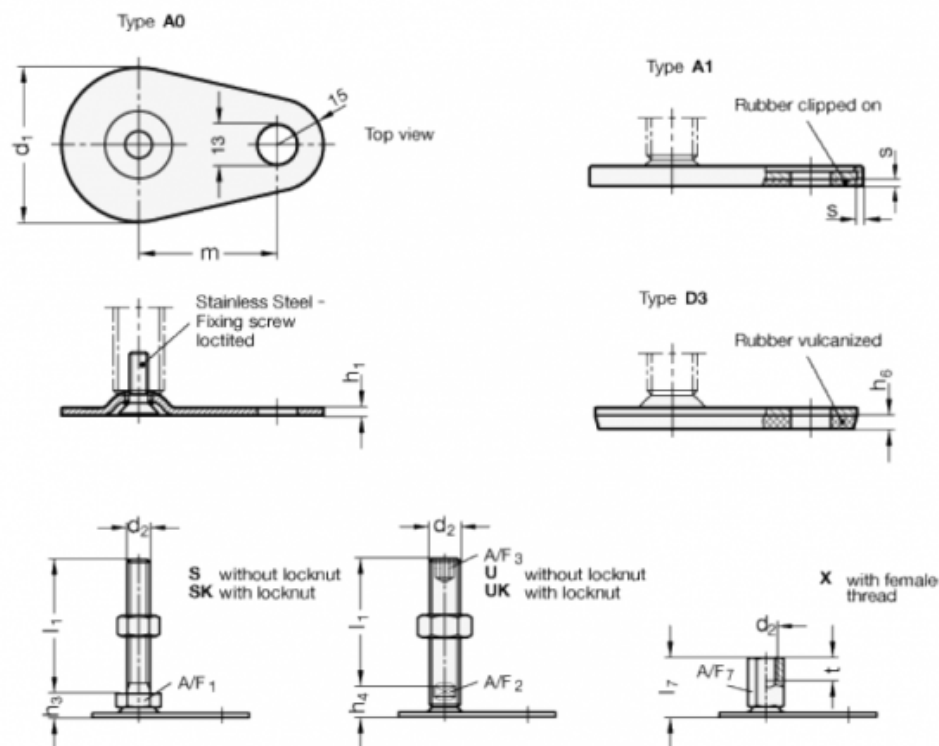

A/F1 = 17

s = 2

d1 = 50

d2 = M12

h1 = 2.5

h3 = 11

h6 =

l1 = 125

m = 45